

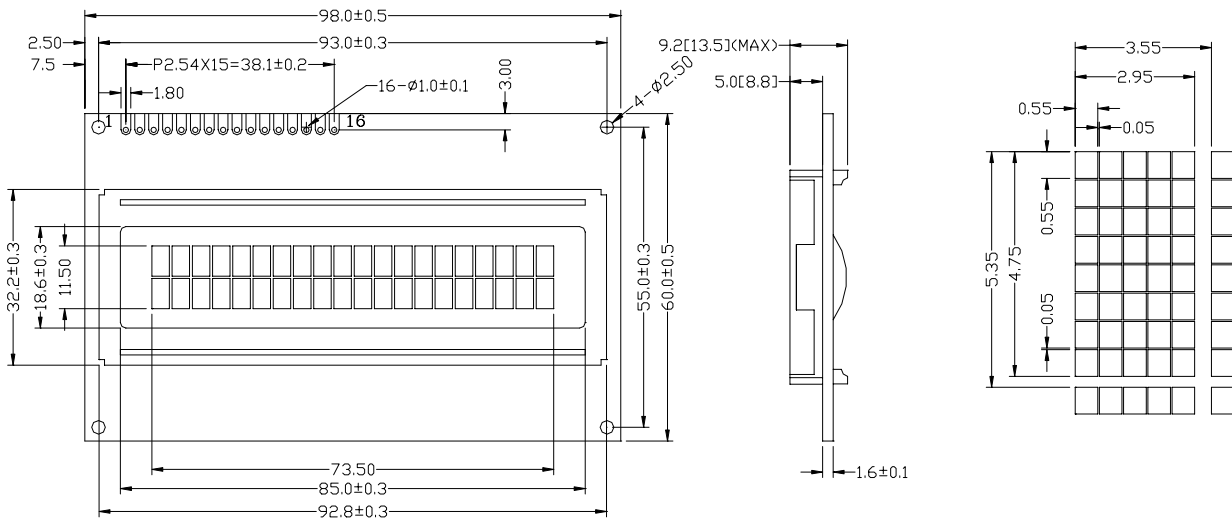

• EXTERNAL DIMENSIONS:

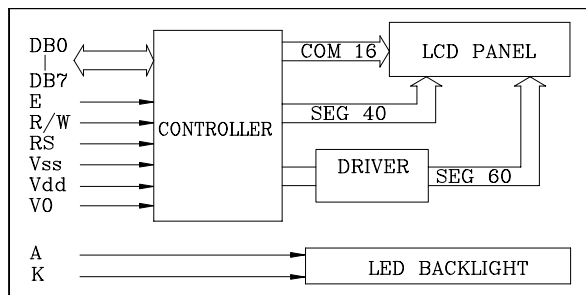

• BLOCK DIAGRAM:



• POWER SUPPLY:

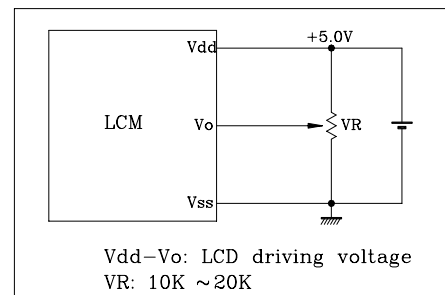

MECHANICAL SPECIFICATIONS

ITEM	SPECIFICATION	UNIT
Module Size (WxHxT)	98.0x60.0x9.2[13.5]	mm
Viewing Area (WxH)	85.0x18.6	mm
Character Font (WxH)	5x7+cursor	dots
Character Size (WxH)	2.95x4.75	mm
Character Pitch (WxH)	3.55x5.35	mm
Dot Size (WxH)	0.55x0.55	mm
Character Type	Eng/Jap, Eng/Eur, Eng/Rus	
LCD MODE	STN(Y/G,Gray,Blue),FSTN	

PIN ASSIGNMENT

PIN	SYMBOL	FUNCTION
1	Vss	Power Supply (0V)
2	Vdd	Power Supply (+5V)
3	Vo	Contrast Adjust
4	RS	Data/Instruction Register Select
5	R/W	Read/Write
6	E	Enable Signal
7~14	DB0~DB7	Data bus Line
15	A	Power Supply for LED BL (+)
16	K	Power Supply for LED BL (-)

ABSOLUTE MAXIMUM RATINGS

PARAMETER	SYMBOL	MIN.	MAX.	UNIT
Power Supply (logic)	Vdd-Vss	-0.3	7.0	V
Power Supply (LCD)	Vdd-Vo	3.0	13.0	V
Input Voltage	Vi	-0.3	Vdd+0.3	V
Operating Temperature	Topr	0	50	°C
Storage Temperature	Tstg	-20	70	°C

ELECTRICAL CHARACTERISTICS (Ta=25°C)

ITEM	SYMBOL	CONDITION	MIN.	TYP.	MAX.	UNIT
Power Supply (logic)	Vdd	-	4.5	5.0	5.5	V
Supply Current (logic)	Idd	VDD=5.0V	0	-	3.0	mA
Driving Voltage (LCD)	Vdd-Vo		4.4	4.7	5.0	V
Driving Current (LCD)	Ilcd		0	-	0.8	mA
Input Voltage "H"	Vih		2.2	-	Vdd	V
Input Voltage "L"	Vil	-0.3	-	0.6	V	
Output Voltage "H"	Voh	Ioh=-0.205mA	2.4	-	-	V
Output Voltage "L"	Vol	Iol=1.2mA	-	-	0.4	V

LED BACKLIGHT SPECIFICATIONS

PARAMETER	TYP.	ITEM	TYP.
Forward Voltage	4.2V	Power Dissipation	588mW
Forward Current	140mA	Emission Wavelength	570nm